

## INSTALLATION INSTRUCTION

- 1 Sling
- 2 Suspension Wire
- 3 Rollerball barrel
- 4 Suspension Channel
- 5 Luminaire
- 6 Fixed Endplate
- 7 Mounting surface
- 8 Beam or Support
- 9 Screw/Fixture

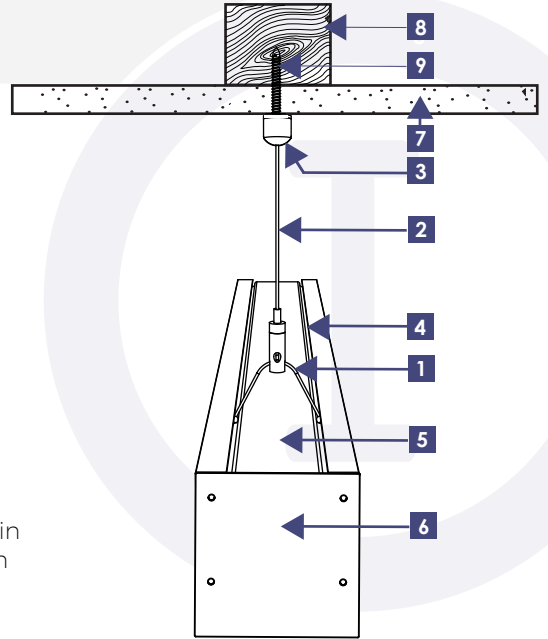

Installer must ensure that the slot orientation in ceiling barrel allows suspension wire to remain perpendicular at all times in all orientations

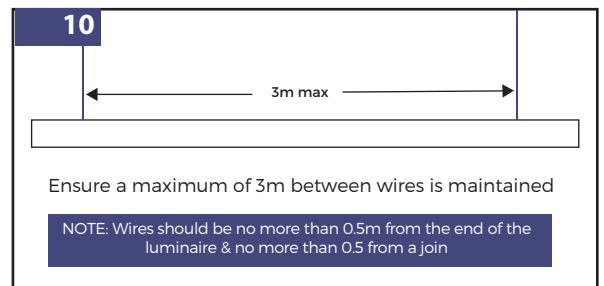
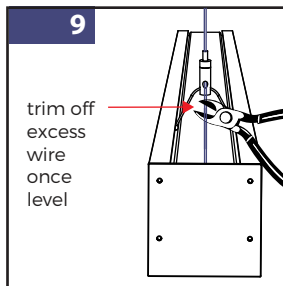
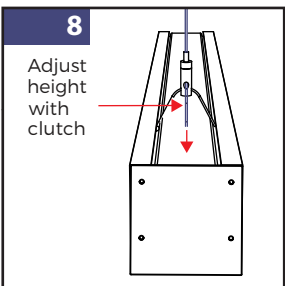
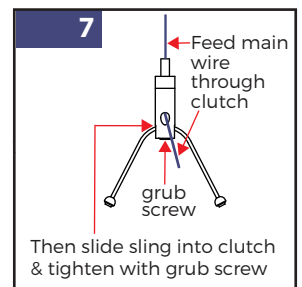
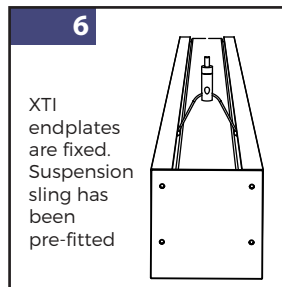
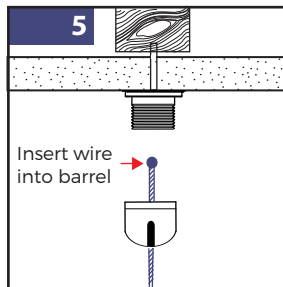
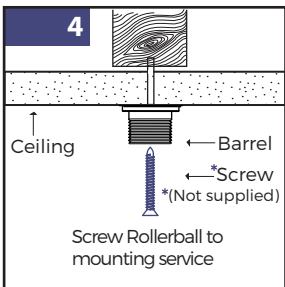
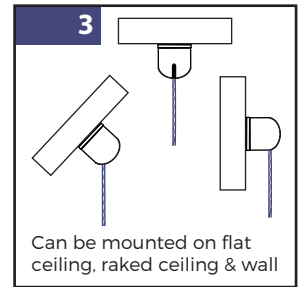
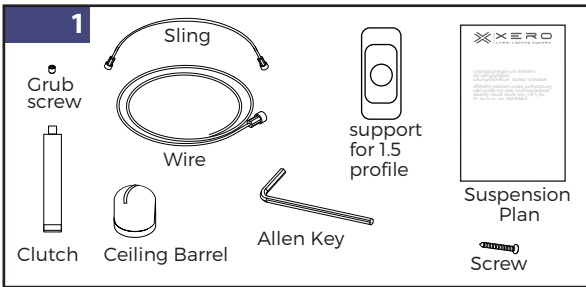

VERSION 2 15.6.2022

If more information is required please contact your local representative by going to [xerolighting.com/contact](http://xerolighting.com/contact) or email us at [headoffice@xerolighting.com](mailto:headoffice@xerolighting.com)