

WIRE SUSPENSION | IP55 version



INSTALLATION INSTRUCTION

1. Sling
2. Suspension Wire
3. Rollerball Barrel
4. Suspension Channel
5. Luminaire
6. End Plate (shown without magnetic cover plate)
7. Mounting surface
8. Beam or support
9. Screw Fixture

Installer must ensure that the slot orientation in ceiling barrel allows suspension wire to remain perpendicular at all times in all orientations

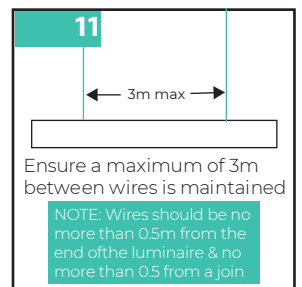
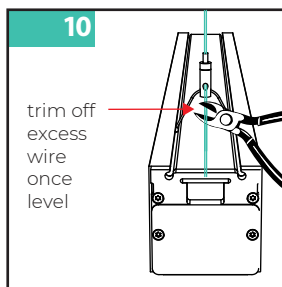
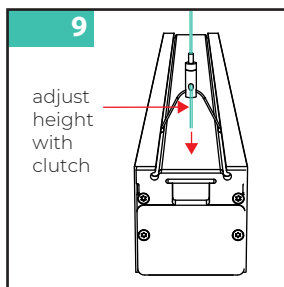
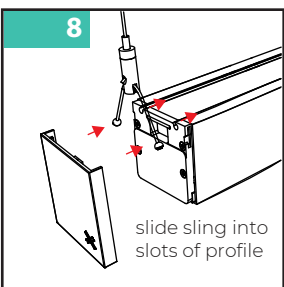
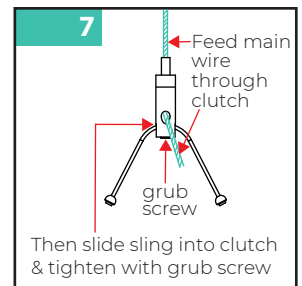
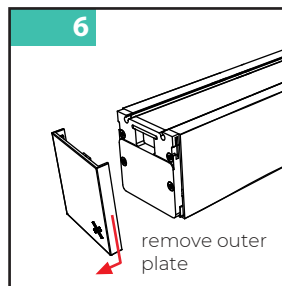
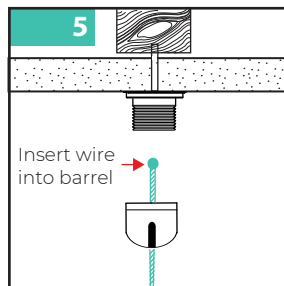
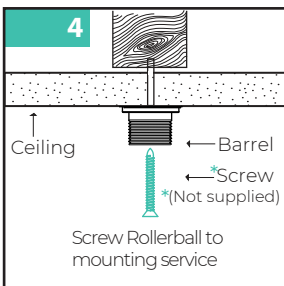
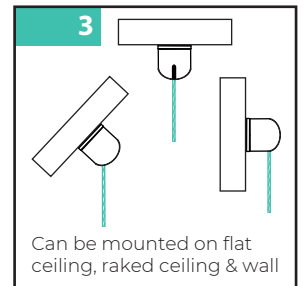
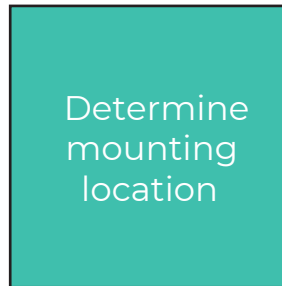
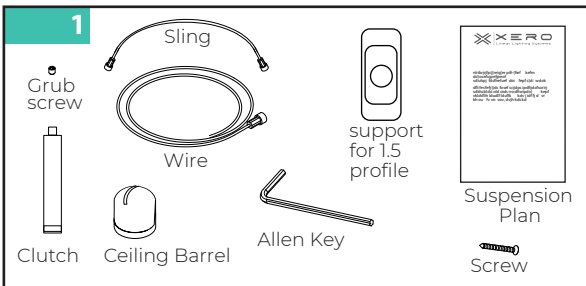
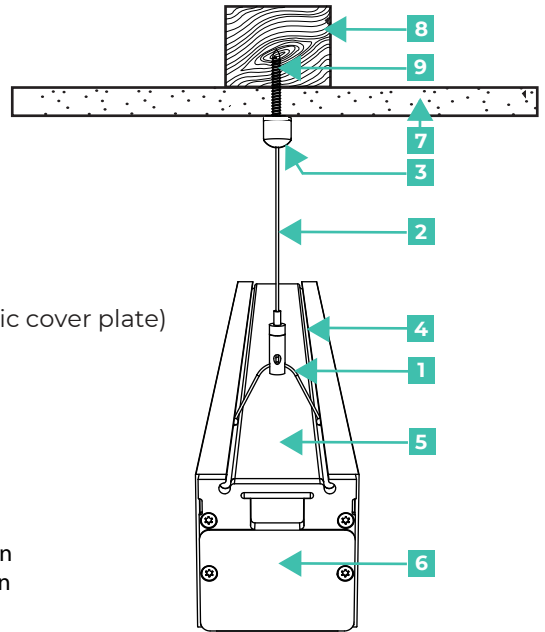

If more information is required please contact your local representative by going to xerolighting.com/contacts or email us at headoffice@xerolighting.com

